

# Tune for Tens

Copyright 2000

All Rights  
Reserved

By Rick  
Stonebraker

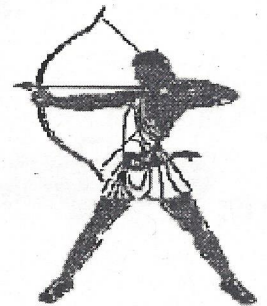

<http://www.texasarchery.org>

<http://www.texasarchery.org/Documents/T4T/TuningForTens.html>

10/9/2001

**FOREWORD**

An important part of archery is the equipment. The skill of the archer is also important but if the bow is not properly tuned, the archer's skill is reduced. Tuning can be achieved in a short period of time by following these steps carefully. The archer that puts the most time and effort into equipment will have the most success.

There are several steps to tuning a recurve bow. Always set the brace height as specified by the manufacturer before you set your nock point. Changing the brace height will nearly always affect the proper nock point. Use the chart at the end of this document to record the brace height and always verify when reassembling your bow.

**SECTION 1: Setting the plunger to proper depth by removing the spring**  
**NOTE:** This step is the same for left (pull bowstring with left hand) and right hand (pull bowstring with right hand) archers:

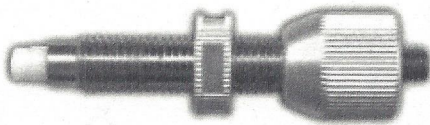
**1A:**  The **PLUNGER** has a **SPRING** to allow horizontal movement of the arrow. When tuned properly, the **PLUNGER** will prevent the arrow from moving in past center in case of a bad shot.

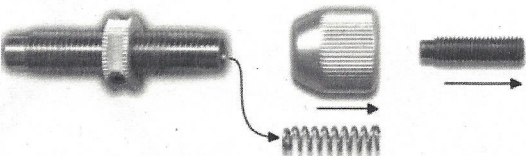
**1B:**  Remove the **SPRING** from the **PLUNGER**.

**1C:**  Needed to make the plunger **STIFF**. (insert in the plunger in place of the spring)

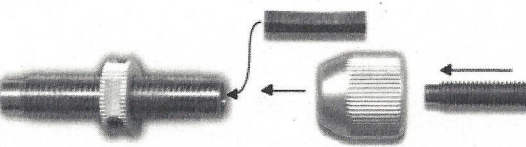
**1D:**  Cut a wooden **MATCH** or piece of **WIRE** about 3/4" long, to use as an insert to make the **PLUNGER** stiff. The **STIFF PLUNGER** will help tune the arrow shaft.

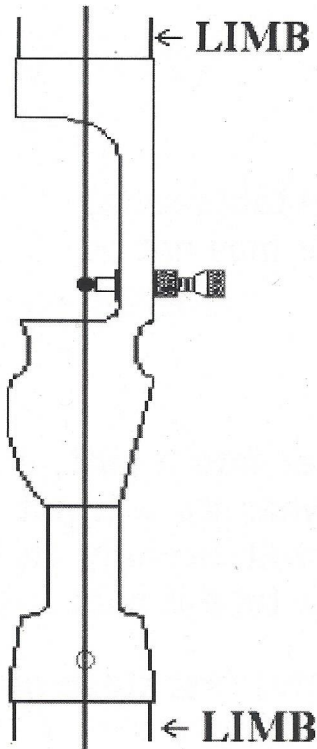
**1E: INSTALL/ADJUST PLUNGER****INSTALL A STIFF PLUNGER**

Remove the center stabilizer and remove the sight if necessary.

Put the bow in a stand or lean the tip of the bow forward against a wall to allow a clear view of the alignment of string and riser/limbs. Do not lean to a side that causes the limb(s) to distort.

The string should be in the center of the limbs.

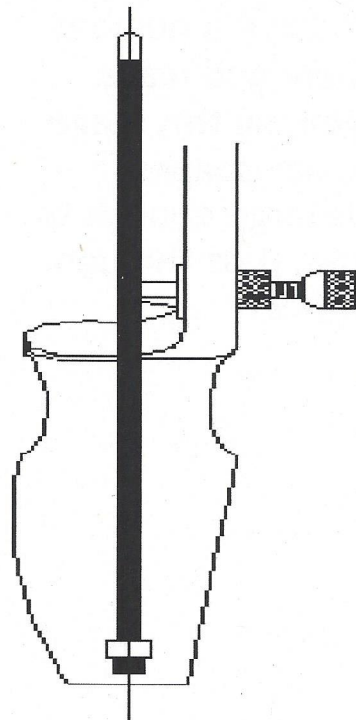
**1F: ADJUST STIFF PLUNGER**

Re-install the stabilizer and sight if removed in step 1E.

Move the stiff plunger in or out so that the bare shaft is directly in the center of the bow.

The string should be in the center of the arrow for this step.

The bow is ready to shoot..

## SECTION 2: PAPER TUNE SETUP

2A: This step will:

- (i) Determine if the nock point is correct. (this is a correctable item)
- (ii) Determine if the arrows are stiff or weak (this may or may not be correctable)

**WHY A BARE SHAFT?** If shot at short distance through paper into a butt, a bare shaft will reveal improper thrust effects since aerodynamics will not have time to straighten out the flight of the arrow. It will literally fly sideways through the paper creating a tell-tale pattern if the tune is bad.

Fletching would straighten out the arrow's flight and make this first stage of tuning more difficult.

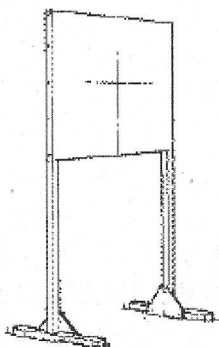

**TUNING FRAME**

The TUNING FRAME consists of a frame to hold a sheet/piece of paper at the proper height in front of the target matt. You will need at least one arrow with no fletchings (aka bare shaft). It is better to have a number of bare shafts so that you can compare them and make sure they all behave the same before beginning this stage of the process. The paper can be tissue, newspaper, paper bag or butcher paper as long as it is large enough to fit the frame and will tear cleanly as arrows pass through.



**BARE SHAFT**

versus

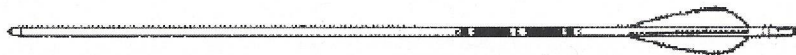

**ARROW**

**2B: METHOD**

The nock point must be set so the thrust of the bowstring pushes the arrow neither up nor down but rather straight forward. Stand 5 to 6 meters from the tuning frame.

The target matt should be 1 to 2 meters behind the frame to allow the bare shaft to pass completely through and clear the paper before it hits the target matt. Shoot the bare shaft though the paper about shoulder height to allow for a parallel flight. The shape of the tear in the paper will indicate the current tune of the bow. Your paper tear may have both a vertical tear and a horizontal tear component.

We will adjust for the vertical tear first.

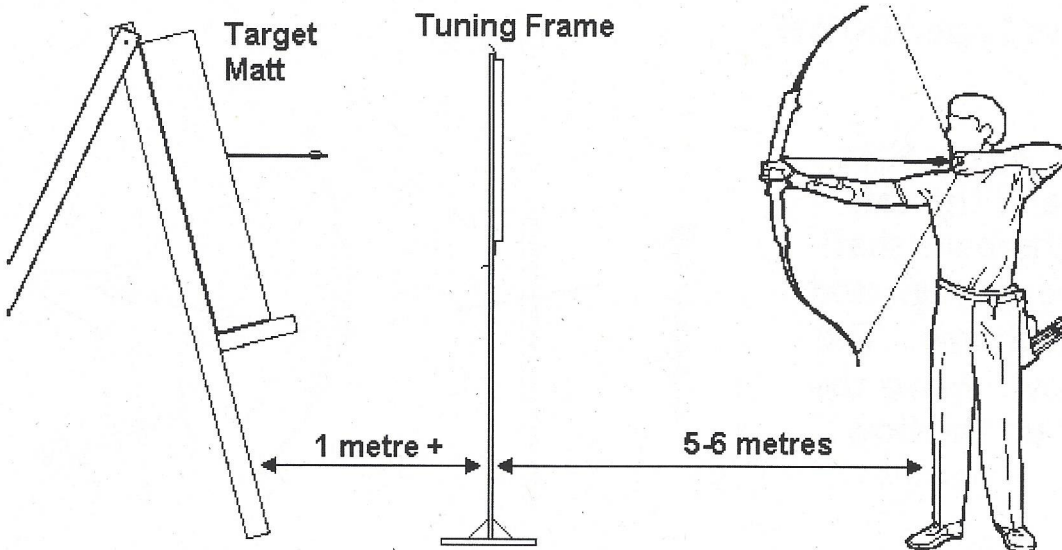

### SECTION 3: SETTING THE NOCK POINT (to control the vertical tear)

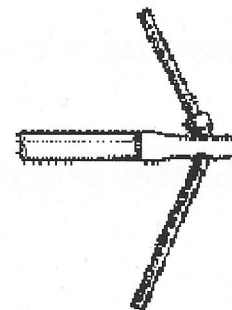

**Nock Point**

### 3A: Bare Shaft Tears Paper UP

TEAR is UP. The arrow flies with the nose down and the tail high. The point of the bare shaft went through the paper low and the nock went through high. The NOCK POINT is too high. Move the NOCK POINT lower down the bow string.

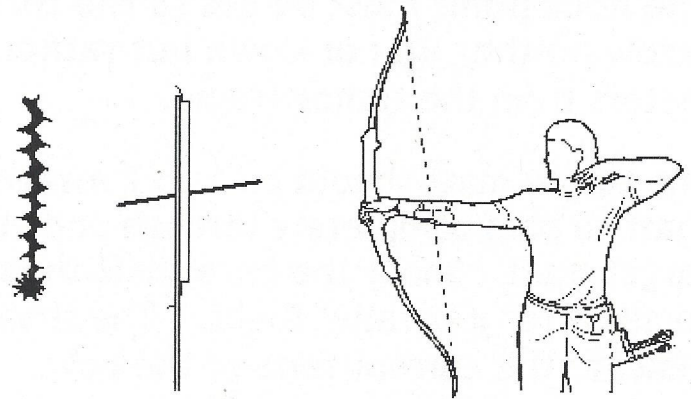

### 3B: Bare Shaft Tears Paper DOWN

TEAR is DOWN. The arrow flies with the nose high and the tail low. The point of the bare shaft went through the paper high and the nock went through low. The NOCK Point is too low. Move the NOCK POINT higher up the bow string.

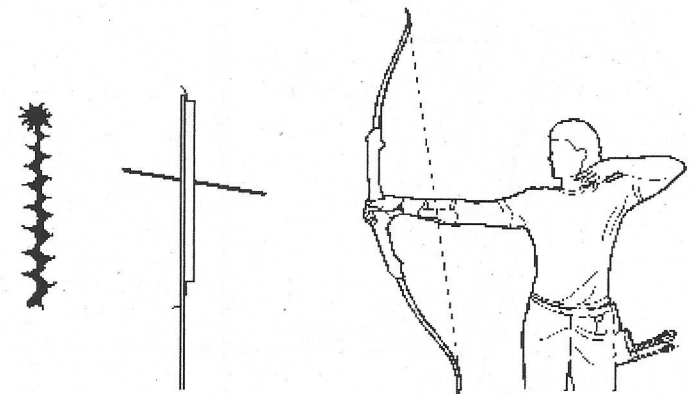

Verify your brace height, and then adjust the NOCK POINT until the tear is neither up nor down.

Shoot as many bare shafts as necessary to be sure of the consistency of your results.

Each step in this process should be completed before beginning the next step.

### 3C: Identifying a LEFT Tear (What is a paper tear to the left?)



The point of the bare shaft went in to the right. The nock tears the paper to the left (leans to the left of the point). In this picture the nock is at the left end, the point made the hole on the right end.

### 3D: Identifying a RIGHT Tear (What is a paper tear to the right?)

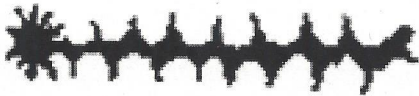

The point of the bare shaft went in to the left. The nock tears the paper to the right (leans to the right of the point). In this picture the point made the hole on the left and the nock is on the right end.

The next section will lead you through adjusting your bow for any horizontal tear. If you have no horizontal tear then just read through Section 4 and proceed to Section 5.

## SECTION 4: HORIZONTAL TEAR

**NOTE:** the following steps are different for right and left hand archers.

Follow the steps that correspond to the hand you use to pull the bowstring. A poor release will cause the shaft to act stiffer and introduce a larger tear. You should make several shots and get similar results on each shot to insure "true" readings.

### 4A: FOR Right-Hand Archers

The figure 3 (to the left) shows a LEFT TEAR.

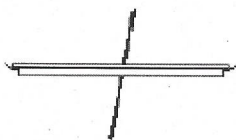

Fig.3

The arrow point is to the RIGHT in the picture and the nock is to the left end of the tear. The shaft is too weak. If the tear is 1 to 3 inches wide, the shaft can be stiffened by decreasing the weight in the point or decreasing bow strength. If the tear is greater than 3 inches, the shaft is too weak to compensate for. Select a stiffer shaft.

The figure 4 shows a RIGHT TEAR.

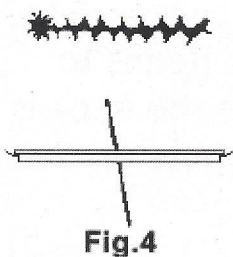

Fig.4

The arrow point is to the left and the nock is to the right end of the tear. The shaft is too stiff. If the tear is 1 to 3 inches wide, the shaft can be weakened by increasing the weight in the point or by increasing bow weight. If the tear is greater than 3 inches, the shaft is too stiff to compensate for. Select a weaker shaft.



A tear less than 1 inch, right or left, is okay.  
A single hole is ideal.

#### 4B: FOR Left-Hand Archers

The figure 3 (to the left) shows a LEFT TEAR. The arrow point is to the right and the nock end is to the left in the tear.

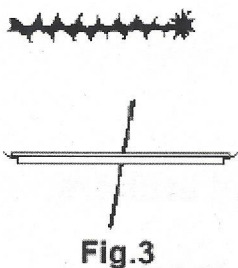

Fig.3

The shaft is too stiff. If the tear is 1 to 3 inches, the shaft can be weakened by increasing the weight in the point or by increasing bow weight. If the tear is greater than 3 inches, the shaft is too stiff to compensate for. Select a weaker shaft.

The figure 4 shows a RIGHT TEAR. The arrow point is to the left and the nock is to the right end of the tear.

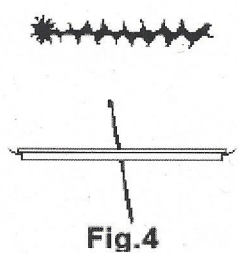

Fig.4

The shaft is too weak. If the tear is 1 to 3 inches, the shaft can be stiffened by decreasing the weight in the point or decreasing bow strength. If the tear is greater than 3 inches, the shaft is too weak to compensate for. Select a stiffer shaft.



A tear less than 1 inch, right or left, is okay.  
A single hole is ideal.



## SECTION 5. PLUNGER TUNING - SPRING TENSION

### 5A. Plunger Tuning For the Right-hand Archer

First adjust your sight. The STIFF PLUNGER is in the center of the bow as per step 1F..

Shoot fletched arrows from 18 meters. Shoot the best group possible in the center of the target.

Adjust the sight if necessary until your grouping is centered on the target.

Remove STIFF PLUNGER and install PLUNGER WITH SPRING to a medium tension setting.

Adjust the PLUNGER until the right edge of the tip of the arrow shaft is in line with the left side of the bow string..

Do not use the right edge of the arrow point but rather the right edge at the end of the arrow shaft.

Shoot fletched arrows from 18 meters but DO NOT ADJUST THE SIGHT.

Correct the flight of the arrow by adjusting the tension of the SPRING in the PLUNGER. Shoot the arrows in the same target and shoot the best group possible.

If the arrows group to the left of the center, weaken the SPRING (Counter-ClockWise).

If the arrows are to the right of center, stiffen the SPRING (ClockWise). Adjust the SPRING until the group is in the center of the target.

The group should be the same as the group you shot using the STIFF PLUNGER/CENTER SHOT METHOD.

For more exact tuning, go to SECTION 6.

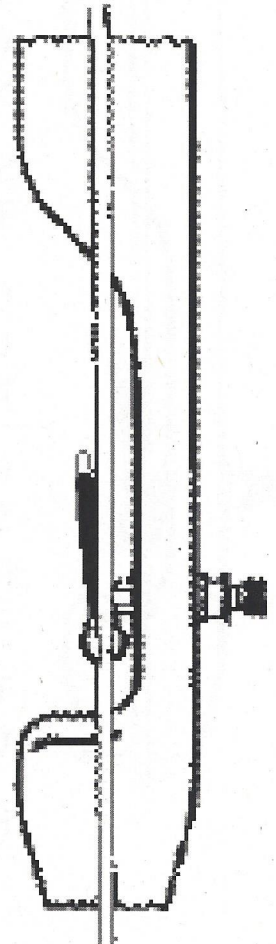

## 5B: Plunger Tuning For the Left Hand Archer

First adjust your sight. The STIFF PLUNGER is in the center of the bow as per step 1F..

Shoot fletched arrows from 18 meters. Shoot the best group possible in the center of the target. Adjust the sight if necessary until your grouping is centered on the target.

Remove STIFF PLUNGER and install PLUNGER WITH SPRING to a medium tension setting.

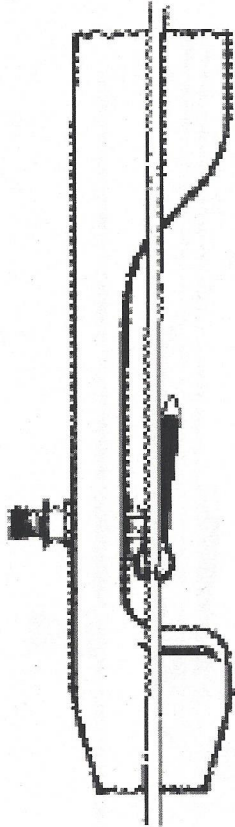

Adjust the PLUNGER until the left edge of tip of the arrow shaft is in line with the right side of the string. Do not use the left edge of the point of the arrow but rather use the left edge of the END of the shaft.

Shoot fletched arrows from 18 meters but DO NOT ADJUST THE SIGHT.

Correct the flight of the arrow by adjusting the tension of the SPRING in the PLUNGER. Shoot the arrows in the same target and shoot the best group possible.

If the arrows group to the right of center, weaken the SPRING (Counter-ClockWise). If the arrows are to the left of center, stiffen the SPRING (ClockWise). Adjust the SPRING until the group is in the center of the target.

This group should be the same as the group you shot using the STIFF PLUNGER/CENTER SHOT METHOD.

For more exact tuning, go to SECTION 6.

## SECTION 6: THE BEGINNING OF FINE TUNING

### 6A: DROP METHOD - YOU MAY NEED TO REPEAT THIS SECTION MORE THAN ONCE TO ACHIEVE TUNE

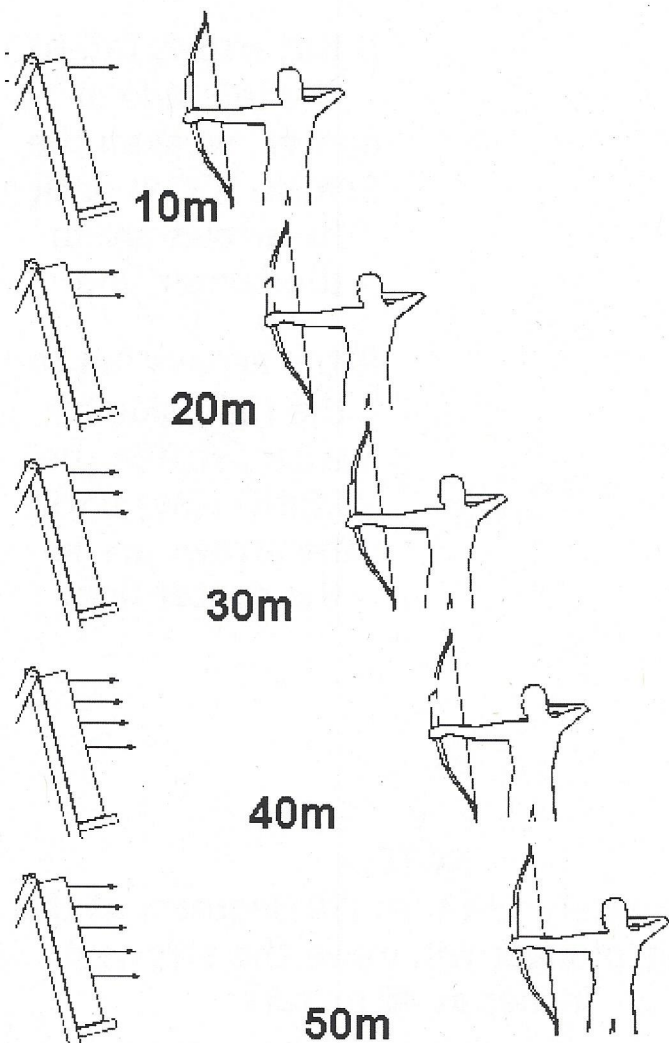

Pick a mark near the top of the target mat. Shoot from 10 meters and adjust the sight if necessary.

If you are not sure of your ability to release each arrow uniformly then you should shoot an end of arrows at each distance to create a grouping each time. You are trying to create a reliable pattern.

Shoot each end then move back 5 meters at a time and continue to shoot at the same mark at the top of the target. Do not adjust the sight! The arrows should impact lower down the target as you move back.

Move back as far as possible without the arrow passing beneath the target mat. This is approximately 40 to 50 meters for most bows.

If the arrows drift to either right or left of center as you move back, more tuning is required. Go to **SECTION 7**.

If the arrows fall in a straight line, the tune is good.

**Step 8** may not be necessary but read over it anyway.

### 6B. PATTERN ANALYSIS OF THE FALLING GROUPS

**FOR LEFT-HAND ARCHERS**

**FALL LEFT**

**FALL RIGHT**

**FOR RIGHT-HAND ARCHERS**

If the arrows fall to the left side of center, stiffen the SPRING (CW) until the arrows are in the center line.

If the arrows fall to the right side of center, weaken the SPRING (CCW) until the arrows are in the center line.

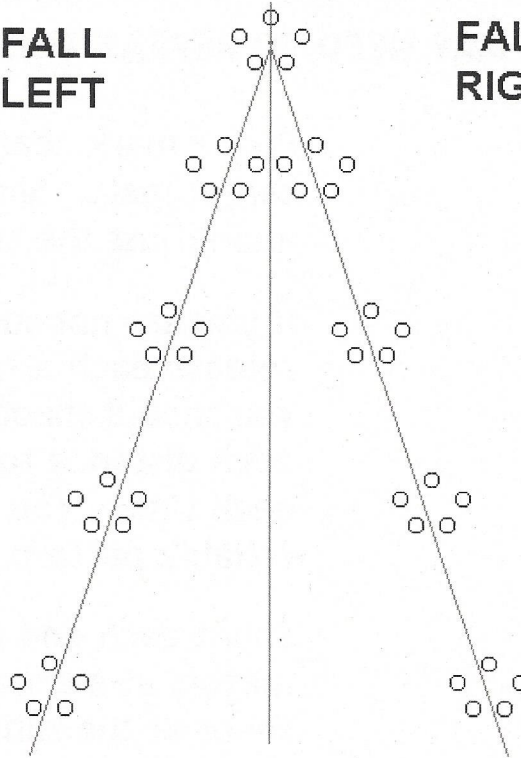

If the arrows fall to the left side of center, weaken the SPRING (CCW) until the arrows are in the center line.

If the arrows fall to the right side of center, stiffen the SPRING (CW) until the arrows are in the center line.

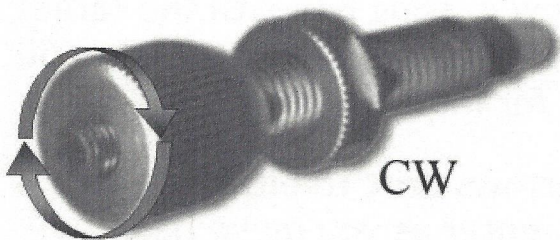

CW

**NOTE:**  
Approximately 1/4 turn (90 degrees) of the spring/plunger will move the arrows 4 inches at 40 meters.

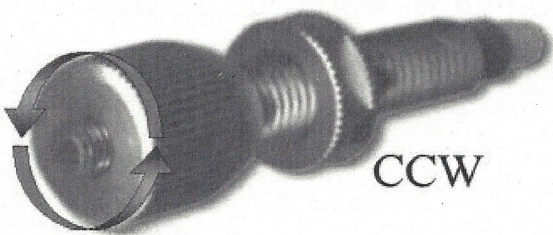

CCW

## SECTION 7: TUNING FOR PERFECTION

This is the beginning of "true" fine tuning. The fine tuning can be done during normal practice but requires consistency to be effective.

Choose a long distance: 60/70 meters for women, 70/90 meters for men. Shoot 6 ends of 6 arrows. Make a chart of the groups using either a drawing of the target or else using a tool such as Target Plot on a Palm Pilot.

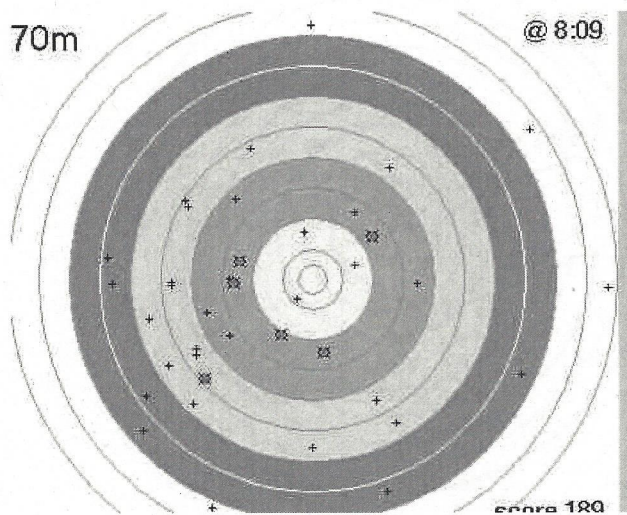

Stiffen the plunger (CW) for about 1/2 turn. Shoot another 6 ends of 6 arrows. Make a new chart for this group and mark on it ONE, 1/2 turn. Again, stiffen the PLUNGER another 1/2 turn, shoot, and chart, repeat and each time mark how many 1/2 turns.

Continue this procedure until the groups start to open up. Be sure to record the number of 1/2 turns on each chart.

Turn the plunger back to the beginning of this exercise. Weaken the PLUNGER by 1/2 turn (CCW) and shoot 6 ends of 6 arrows. Chart the groups and the 1/2 turns. Repeat the exercise as before until the groups begin to open up.

Review all the charts and find the best group. Adjust the PLUNGER to the turns for that chart. This should be the best tune.

If there is time and patience on your part, repeat the above exercise using 1/4 and 1/8 turns.

**Excellence takes persistence!**

## SECTION 8: MAKING A BASELINE RECORD

Go to 18 meters and shoot a group in the center of the target. Now shoot a bare shaft (or several) and note where it/they hit on the target in relation to the group.

For example, see the Figure 1 to the right. The fine tuning has found a better set-up. Do not be concerned if the bare shaft did not group with the fletched arrows.

**NOTE:** It is important to record where the bare shaft hits in relation to the group. Record this in Figure 2 for later use.

If an emergency arises where the bow needs to be re-tuned quickly, set the nock point, then adjust the spring tension until the bare shaft hits relative to where the group is, as you recorded using figure 2.

Figure 1:

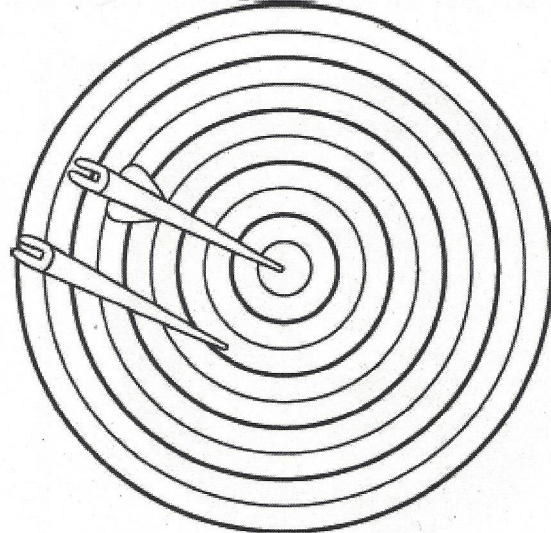
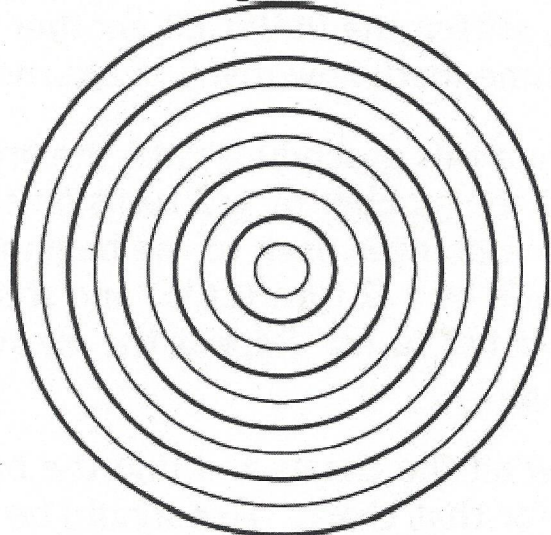
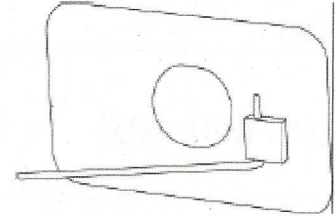

Figure 2:



## SECTION 9: INDEX YOUR NOCKS

How do you know if the arrow's vanes are touching the arrow rest or a part of the shelf when you shoot? Put some red lipstick on the support arm of the arrow rest. See figure 1 to the right. Shoot some arrows and if the vanes have red on them, they are making contact. If there is some lipstick on the vanes, rotate the nock, shoot, rotate again, until there isn't any lipstick on the vanes.



Orienting nocks using the middle of the valley between fletch vanes may not be the best clearance for your arrows. You want to find the midpoint away from the rest in both directions in order to determine maximum clearance. Turn the nock and shoot until the vane begins to rub. Make a mark on the shaft directly opposite the mold mark on the nock. See figure 2. This is where the rub starts for that particular vane.



Turn the nock in the opposite direction and repeat the above procedure until the next vane begins to rub. Make another mark opposite the mold mark on the nock. These two marks indicate where the two vanes rub the bow. Turn the nock until the mold mark is directly in between these two marks.

This should be the point of maximum clearance. Mark every arrow the same (see figure 3.)

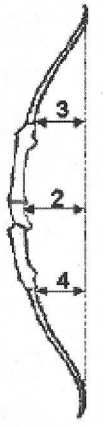

### 11. RECORD IMPORTANT INFORMATION

DATE:	Outdoor	Indoor	Notes	
Riser (brand, height)				
Limbs(brand,wt & length)				
Upper Tiller (#3)				
Brace Height (#2)				
Lower tiller (#4)				
Length of string				
Type and number of strands				
Nock point				
Sight used				
Arrow brand and size				
Arrow length				
Type of point and weight				
Type of nock				
Type, Color, size of fletching				
Plunger				
Distance from Nockpoint to Kisser				

**Note from the author:**

This method has been used for many years by some of the top archers. There are quicker methods but I believe this is the most complete. This method tunes and gives an idea of how the equipment works. Rick Stonebraker.